

**Name:** 10s-4-3  
**Type:** Control valves - 10s type  
**Subtype:** Medium parameters valves  
**Operating medium:** water-steam  
**Body material:** 20



#### DESCRIPTION:

Control valves are the most used valve type designed for continuous or discrete adjustment of flow and pressure.

#### TECHNICAL DATA:

Diameter, DN: 32 mm  
Pressure, PN: 10 MPa  
Temperature: 450 C°  
Maximum pressure differential: 1 MPa  
Discharge rate (Kv100): 2.7 m<sup>3</sup>/h  
Rotational moment on the shaft: 70 Ngm  
Number of revolutions: 6  
Operating stroke: 24 mm

#### DIMENSIONS:

D1 (D3): 32 mm  
D2 (D4): 40 mm  
L: 230 mm  
H: 303 mm  
A: 47 mm  
Weight: 6.7 кг

#### ACTUATOR:

Control type: M  
Actuator model: -  
Actuator power: 0 kW  
Full stroke time: 0 s

#### DIMENSIONAL DRAWING:

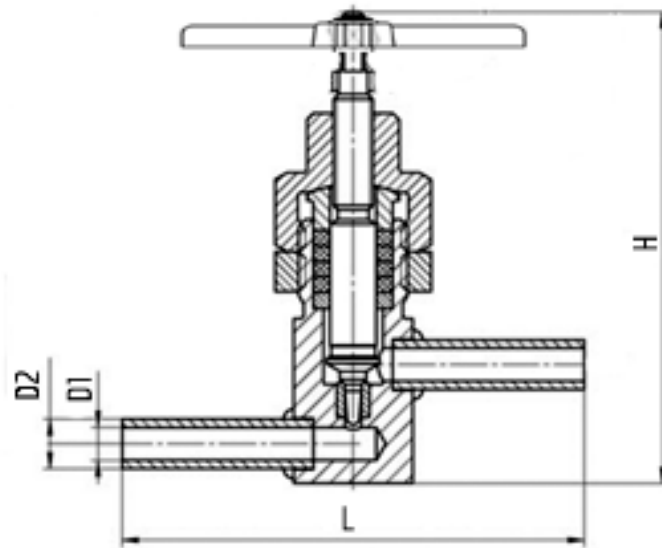

A