

Name: LPRF-80-75-10-E5-22

Russian name: ВЛЦ-4-75 №10 Исп.5, 22 кВт

Type: Low pressure radial fans

Notes: It is recommended to use vibration isolators of CVI-43 type in quantity of 5 pcs.

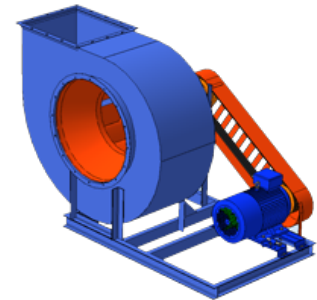

DESCRIPTION:

Low pressure radial fans of LPRF-80-75 type are widely used in air ventilation systems of industrial and civil buildings, in air conditioning systems and for other industrial and sanitary-engineering purposes. These low pressure fans are manufactured in right-hand and left-hand rotations with backward curved blades. In accordance with the field of application LPRF-80-75 type fans can be produced in the following modifications:

-
 - general purpose industrial modification (carbon steel)
-
 - corrosion-resistant modification (stainless steel)
-
 - explosion-proof modification (dissimilar metals)
-
 - explosion-proof and corrosion-resistant modification (dissimilar metals)
-
 - explosion-proof modification (aluminum alloys)
-
 - corrosion-resistant modification (titanium alloys)
-
 - heat-resistant modification (carbon steel)
-
 - heat-resistant and corrosion-resistant modification (stainless steel)

AERODYNAMIC PERFORMANCE:

Capacity: 45.8 ths. m³
Total pressure: 1800 Pa
Temperature: 80 C
Efficiency: 69-82 %
Dustiness: 0.1 g/m³

DIMENSIONS:

Length: 1610 mm
Width: 1780 mm
Height: 1850 mm
Weight: 757 kg

ELECTRIC MOTOR:

Power: 22 kW

Rate speed: 1000 rpm
Moment of inertia: n/a kg*m²

AUXILIARIES:
Actuator: n/a Hm

DELIVERY OPTIONS:
Railway: Flatcar: 1 | Open wagon: 0 | Schnabel car: 0

DIMENSIONAL DRAWING:

