

Name: LPRF-80-75-16-E5-30

Russian name: ВЛ-4-75 №16 Исп.5, 30 кВт

Type: Low pressure radial fans

Notes: It is recommended to use vibration isolators of CVI-45 type in quantity of 8 pcs.

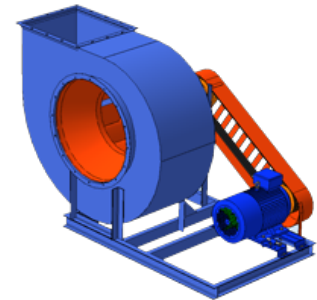

DESCRIPTION:

Low pressure radial fans of LPRF-80-75 type are widely used in air ventilation systems of industrial and civil buildings, in air conditioning systems and for other industrial and sanitary-engineering purposes. These low pressure fans are manufactured in right-hand and left-hand rotations with backward curved blades. In accordance with the field of application LPRF-80-75 type fans can be produced in the following modifications:

-
 - general purpose industrial modification (carbon steel)
-
 - corrosion-resistant modification (stainless steel)
-
 - explosion-proof modification (dissimilar metals)
-
 - explosion-proof and corrosion-resistant modification (dissimilar metals)
-
 - explosion-proof modification (aluminum alloys)
-
 - corrosion-resistant modification (titanium alloys)
-
 - heat-resistant modification (carbon steel)
-
 - heat-resistant and corrosion-resistant modification (stainless steel)

AERODYNAMIC PERFORMANCE:

Capacity: 95.0 ths. m³
Total pressure: 1020 Pa
Temperature: 80 C
Efficiency: 70-84 %
Dustiness: 0.1 g/m³

DIMENSIONS:

Length: 2600 mm
Width: 2910 mm
Height: 2462 mm
Weight: 2690 kg

ELECTRIC MOTOR:

Power: 30 kW

Rate speed: 1000 rpm
Moment of inertia: n/a kg*m²

AUXILIARIES:
Actuator: n/a Hm

DELIVERY OPTIONS:
Railway: Flatcar: 1 | Open wagon: 0 | Schnabel car: 0

DIMENSIONAL DRAWING:

