

Name: MPRF-180-55-12-E5-45

Russian name: ВЛ 9-55 №12 Исп.5, 45 кВт

Type: Medium pressure radial fans

Notes:

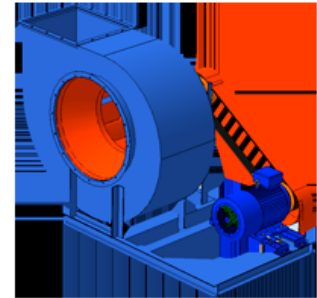

DESCRIPTION:

Medium pressure radial fans of MPRF-180-55 type are widely used in air ventilation and air conditioning systems of industrial and civil buildings and for other industrial and sanitary-engineering purposes. These medium pressure fans are manufactured in right-hand and left-hand rotations with backward curved blades. In accordance with the field of application these fans can be produced in the following modifications:

 - general purpose industrial modification (carbon steel)

 - corrosion-resistant modification (stainless steel)

 - corrosion-resistant modification (titanium alloys)

AERODYNAMIC PERFORMANCE:

Capacity: 65.0 ths. m³

Total pressure: 1380 Pa

Temperature: 80 C

Efficiency: 40-64 %

Dustiness: 0.1 g/m³

DIMENSIONS:

Length: 2000 mm

Width: 3200 mm

Height: 1832 mm

Weight: 1645 kg

ELECTRIC MOTOR:

Power: 45 kW

Rate speed: 1000 rpm

Moment of inertia: n/a kg*m²

AUXILIARIES:

Actuator: n/a Hm

DELIVERY OPTIONS:

Railway: Flatcar: 1 | Open wagon: 0 | Schnabel car: 0

DIMENSIONAL DRAWING:

