

Name: HPRF-120-28-8-E5-30

Russian name: BP 6-28 №8 Исп.5, 30 кВт

Type: High pressure radial fans

Notes: It is recommended to use vibration isolators of CVI-43 type in quantity of 5 pcs.

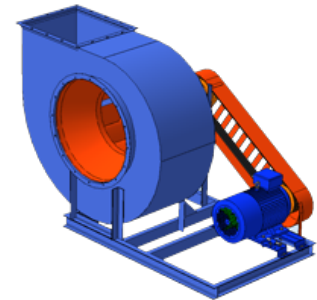

DESCRIPTION:

High pressure radial fans of HPRF-120-28 type are widely used in air ventilation and air conditioning systems of industrial and civil buildings and for other industrial and sanitary-engineering purposes. These high pressure fans are manufactured in right-hand and left-hand rotations with backward curved blades. In accordance with the field of application these fans can be produced in the following modifications:

-
 - general purpose industrial modification (carbon steel)
-
 - corrosion-resistant modification (stainless steel)
-
 - explosion-proof modification (dissimilar metals)
-
 - explosion-proof and corrosion-resistant modification (dissimilar metals)
-
 - corrosion-resistant modification (titanium alloys)

AERODYNAMIC PERFORMANCE:

Capacity: 14.0 ths. m³
Total pressure: 5000 Pa
Temperature: 80 C
Efficiency: 57-72 %
Dustiness: 0.1 g/m³

DIMENSIONS:

Length: 1110 mm
Width: 2046 mm
Height: 1313 mm
Weight: 720 kg

ELECTRIC MOTOR:

Power: 30 kW
Rate speed: 1500 rpm
Moment of inertia: n/a kg*m²

AUXILIARIES:

Actuator: n/a Hm

DELIVERY OPTIONS:

Railway: Flatcar: 1 | Open wagon: 0 | Schnabel car: 0

DIMENSIONAL DRAWING:

