

**Name:** LPRF-80-75-12.5-E5-15

**Russian name:** ВЛ-4-75 №12,5 Исп.5, 15 кВт

**Type:** Low pressure radial fans

**Notes:** It is recommended to use vibration isolators of CVI-43 type in quantity of 6 pcs.

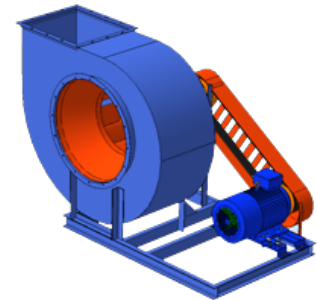

## DESCRIPTION:

Low pressure radial fans of LPRF-80-75 type are widely used in air ventilation systems of industrial and civil buildings, in air conditioning systems and for other industrial and sanitary-engineering purposes. These low pressure fans are manufactured in right-hand and left-hand rotations with backward curved blades. In accordance with the field of application LPRF-80-75 type fans can be produced in the following modifications:

- <br> - general purpose industrial modification (carbon steel)
- <br> - corrosion-resistant modification (stainless steel)
- <br> - explosion-proof modification (dissimilar metals)
- <br> - explosion-proof and corrosion-resistant modification (dissimilar metals)
- <br> - explosion-proof modification (aluminum alloys)
- <br> - corrosion-resistant modification (titanium alloys)
- <br> - heat-resistant modification (carbon steel)
- <br> - heat-resistant and corrosion-resistant modification (stainless steel)

## AERODYNAMIC PERFORMANCE:

Capacity: 36.3 ths. m<sup>3</sup>  
Total pressure: 1185 Pa  
Temperature: 80 C  
Efficiency: 69-82 %  
Dustiness: 0.1 g/m<sup>3</sup>

## DIMENSIONS:

Length: 1875 mm  
Width: 2225 mm  
Height: 2135 mm  
Weight: 964 kg

## ELECTRIC MOTOR:

Power: 15 kW

Rate speed: 1000 rpm  
Moment of inertia: n/a kg\*m<sup>2</sup>

AUXILIARIES:  
Actuator: n/a Hm

DELIVERY OPTIONS:  
Railway: Flatcar: 1 | Open wagon: 0 | Schnabel car: 0

DIMENSIONAL DRAWING:

