

**Name:** MPRF-180-55-12-E5-55

**Russian name:** ВЛ 9-55 №12 Исп.5, 55 кВт

**Type:** Medium pressure radial fans

**Notes:**

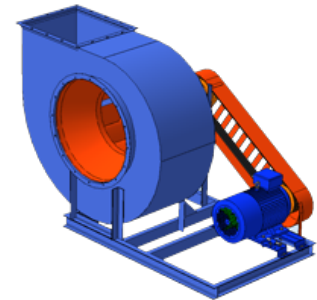

## DESCRIPTION:

Medium pressure radial fans of MPRF-180-55 type are widely used in air ventilation and air conditioning systems of industrial and civil buildings and for other industrial and sanitary-engineering purposes. These medium pressure fans are manufactured in right-hand and left-hand rotations with backward curved blades. In accordance with the field of application these fans can be produced in the following modifications:

<br> - general purpose industrial modification (carbon steel)

<br> - corrosion-resistant modification (stainless steel)

<br> - corrosion-resistant modification (titanium alloys)

## AERODYNAMIC PERFORMANCE:

Capacity: 73.0 ths. m<sup>3</sup>

Total pressure: 1550 Pa

Temperature: 80 C

Efficiency: 40-64 %

Dustiness: 0.1 g/m<sup>3</sup>

## DIMENSIONS:

Length: 2000 mm

Width: 3200 mm

Height: 1832 mm

Weight: 1685 kg

## ELECTRIC MOTOR:

Power: 55 kW

Rate speed: 1000 rpm

Moment of inertia: n/a kg\*m<sup>2</sup>

## AUXILIARIES:

Actuator: n/a Hm

DELIVERY OPTIONS:

Railway: Flatcar: 1 | Open wagon: 0 | Schnabel car: 0

DIMENSIONAL DRAWING:

